

D07RE5

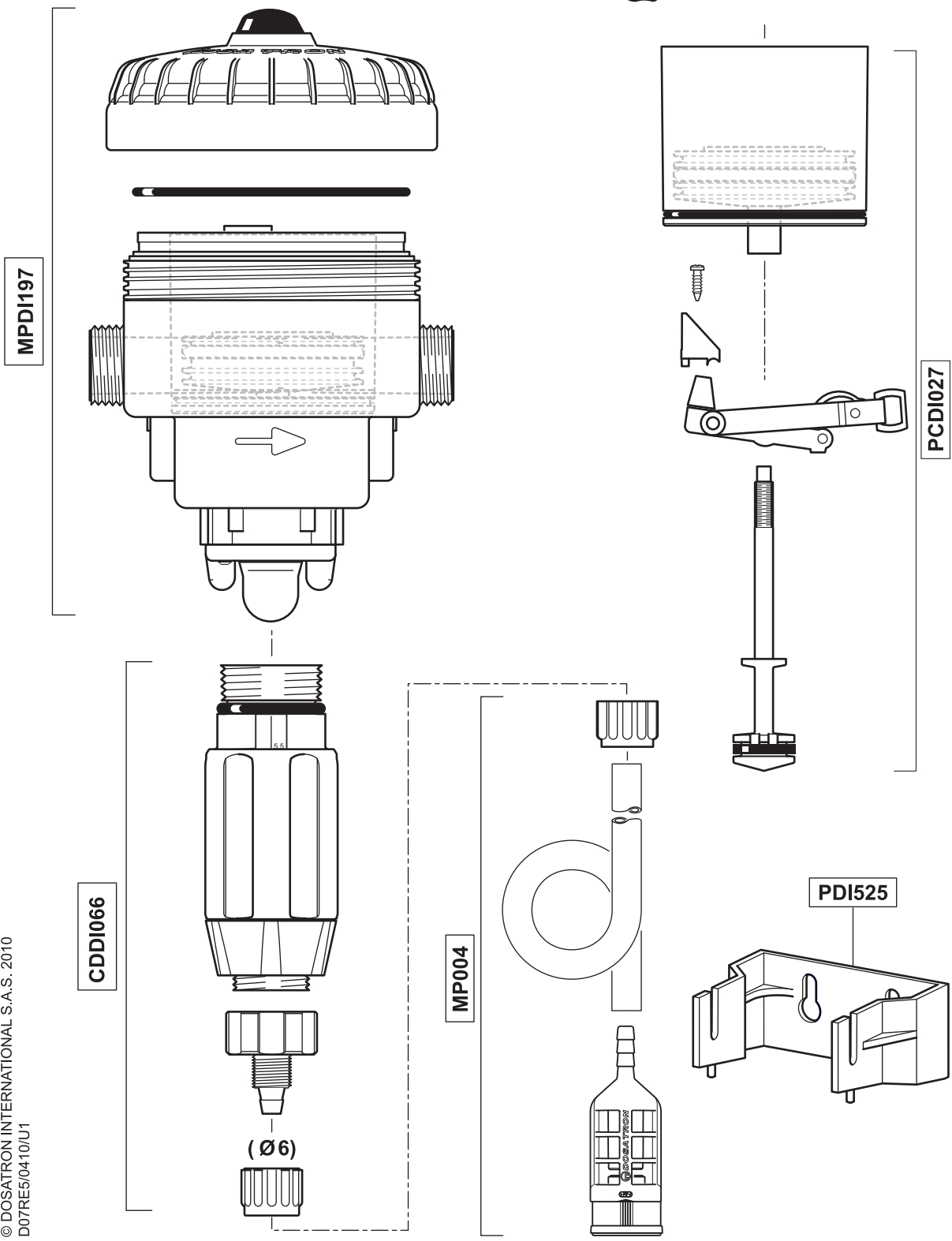

0.7 m³/h - 0.8 - 5.5%
3 GPM - 1:128 - 1:18
0.3 - 6 bar
4.3 - 85 psi



D07RE5

0.7 m³/h - 0.8 - 5.5%
3 GPM - 1:128 - 1:18
0.3 - 6 bar
4.3 - 85 psi

